

Before Using the Driving Support Function

Adjusting the Settings to Match the Vehicle

Before using the driving support function, set the mounting height of the device from the road surface and adjust the horizon and bonnet front edge position settings to match the vehicle.

1. Press the [MENU/OK] button.

MENU appears.



2. Use the [▲]/[▼] buttons to select <Driving support settings> and then press the [MENU/OK] button.

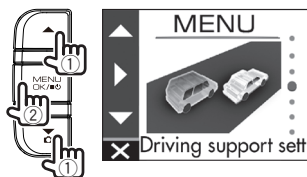

3. Use the [▲]/[▼] buttons to select <Mounting height settings> and then press the [MENU/OK] button.

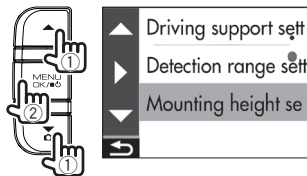

4. Use the [▲]/[▼] buttons to select the mounting height from the road surface and then press the [MENU/OK] button.

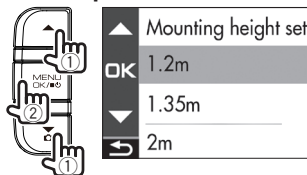

5. Use the [▲]/[▼] buttons to select <Detection range settings> and then press the [MENU/OK] button.

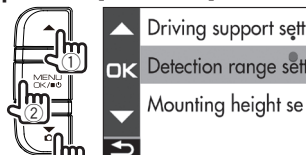

6. Press the [MENU/OK] button.



7. Adjust the installation angle of the device and then fix the device in place.

Turn the angle adjustment knob clockwise before adjustment. For the proper installation of the device, adjust your device to align the white horizontal line with the horizon, and the red vertical line with the center of the driving lane. Also the picture ratio of sky portion to road portion should be 50 to 50 as shown the picture below. After adjusting the installation angle, turn the angle adjustment knob of the adjustment bracket.

Adjustment example

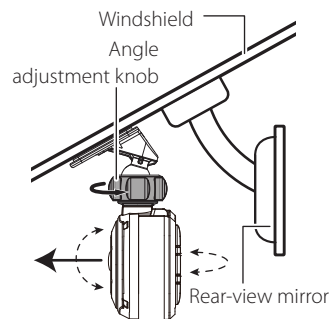
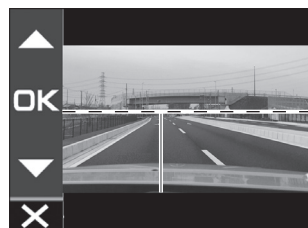

Fine adjusting the guide line (white line) with the horizon

Use the [▲]/[▼] buttons to align the guide line (white line) with the horizon, and then press the [MENU/OK] button.

Adjust as shown in the figure.

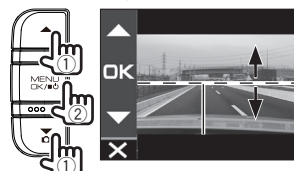

8. Press the [MENU/OK] button, use the [▲]/[▼] buttons to align the guide line with the bonnet front edge, and then press the [MENU/OK] button.

Adjust as shown in the figure.

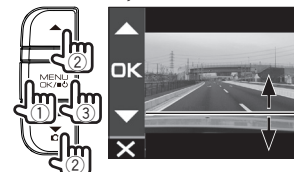

9. Hold down the [REC/↵] button to end the procedure.



- As for guide of the mounting height setting is; 1.2m: Sedan and small SUV, 1.35m: SUV and large van, 2m: for bus and truck.
- Adjust the hood guide line to the bottom of the screen when hood of a vehicle is invisible.
- The driving support function is set to "OFF" by default (→P.21).